



Features >

- Sourced by high output 2835 LED, good color conformity and no spot.
- 99.99% gold thread, pure copper bracket coated with silver.
- SDCM \leq 5 each BIN.
- Special lens design, 160°beaming angle with even light.
- Overmoulded: anti-dusting, anti-moisture, waterproof, anti-shock.
- 50 pcs Max. in a series connection.
- CE, RoHS and UL certified.

Application >

- Best for 6-15 cm depth signs at airports, metros, banks, buildings and shopping malls, etc.
- Best for 6-15 cm depth single-sided light box at airports, metros, banks, buildings and shopping malls, etc.

Parameters >

Items	Parameters
Part Number	LED modul 2W 3čip 7716-160-CW-230V
CCT (K)	7000K
Beaming Angle (°)	160
CRI (Ra)	≥70
Luminous Flux (lm)	150
Voltage (V)	AC220V
Power (W)	2
Driving Method	Inner Constant Current
Dimension (mm)	86*19*8.3
Weight (g)	15.5
Working Tem. (°C)	-25 ~ +60
Storage Tem. (°C)	-25 ~ +70
Protection Grade	IP65

Dimension >

Unit:mm

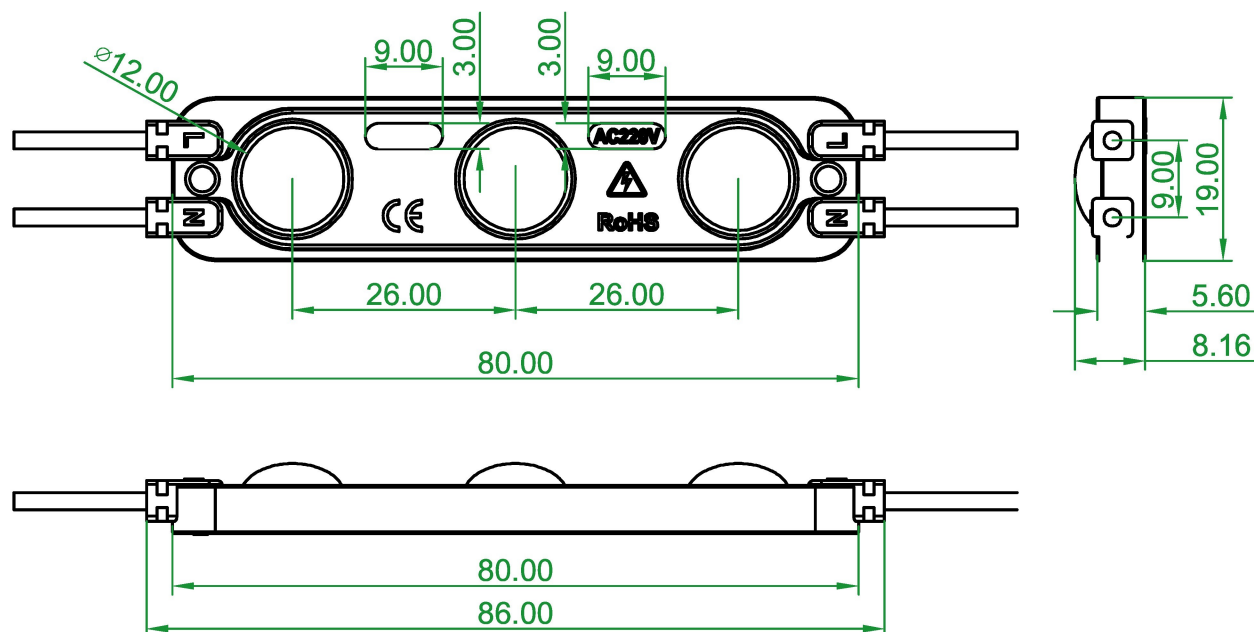

Beaming Angle >

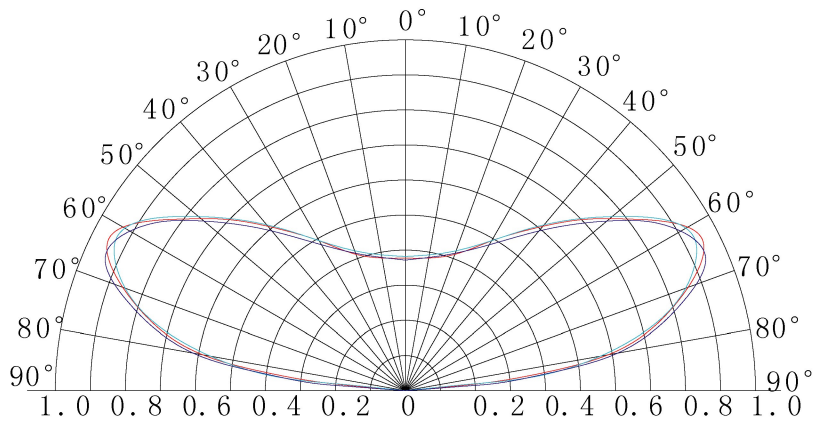

Reference Scheme >

Depth(mm)	Distance(mm)	Density(pcs/m ²)	Illumination(lux)
Dz=60	Dx=80 Dy=80	60	3800-4200
Dz=80	Dx=80 Dy=80	60	3400-3800
Dz=100	Dx=80 Dy=80	60	3000-3400
Dz=120	Dx=80 Dy=80	60	2600-3000

Remark:

- The transmittance of the advertising fabric was 32%.
- The above data is for reference only.

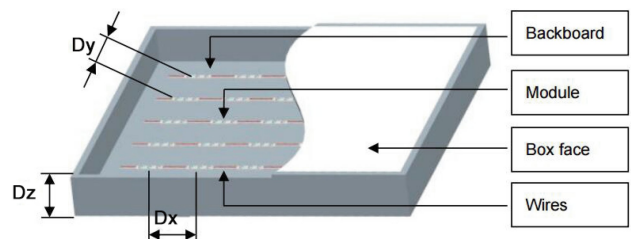

Wire Connection >

White&Red wire to positive

White&Black wire to negative

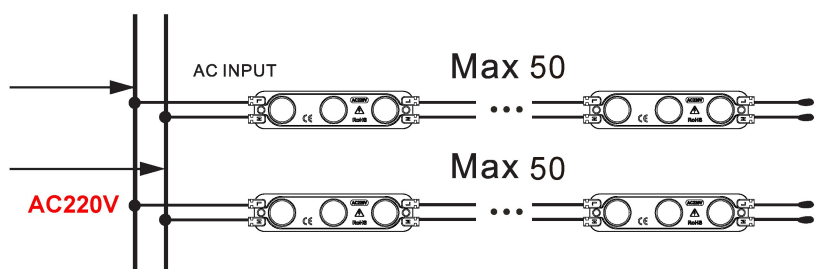

Packing

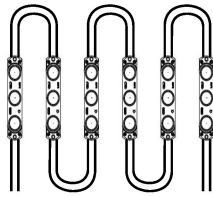

50cs in a string

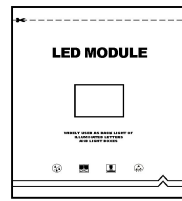

100pcs in a plastic tray

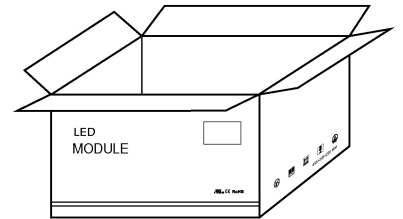

1000 pcs in a carton

Packing Specification



- Packed in plastic tray.
- Packing information

Part Number	
Carton Dimension(mm)	490*450*220
Trays per carton	20
Quantity per carton(pcs)	1000
Net Weight(kg)	12.0(1±10%)
Gross Weight(kg)	13.0(1±10%)

Due to the packing manner difference, please subject to the original products in case of discrepancy found between the picture and actual product.

Warning



- Disassembling or modifying the product is forbidden.
- Installation with power on is forbidden.
- Any organic solvent chemical is forbidden.
- Acidic or alkaline adhesive is forbidden when install, neutral glass cement could be used for installation purpose, make it drying in open environment for four hours.
- Isolation and corrosion prevention on all wiring points and wire ends.
- Make sure the power wire is thick enough and ensure the voltage and connections are connected correctly before power on.
- This product should be used in a sign, do not expose it in opening site.
- Installation, maintaining should be done by professional staff.
- 50 pcs in a serial connection maximum.
- The power wire between power supply and module should be less than two meters to keep the same brightness on all parts.
- Initial location with 3M tape, then secure with screws.

Declaration



- Warranty: 3 years.
- In order to ensure the safety, the broken wires need to be replaced by the manufacturer or the service agent, or by the staff with the similar qualification.
- The given data in the specification was based on the laboratory testing, there may be discrepancy found in the actual products.
- The given drawings in the specification are only for reference, there may be discrepancy found in the actual products.
- The products are subject to change without prior notification.



RoHS

Company Address:

Rm. WS, 9F, LuBan Building, Hongli West Road, Futian District,
Shenzhen, China 518034

Factory Address:

No. B, Xinyongfeng Industrial Area, Yingrenshi Village, Shiyuan Town,
Bao'an District, Shenzhen, China 518000

TEL: +86-755-83544570

FAX: +86-755-83056229

Website: www.lbyled.com

E-mail: info@lbyled.com



LBY LED®
signs never been so easy